



Valves, measurement and control systems for  
biogas plants and biomethane treatment



## Application-based solutions for your project business

Having excellent references in the area of industrial markets shows that we clearly understand your requirements. With our wide range of products relating to valves, measurement and control systems, we comply with the requirements of various procedures in biogas generation and the treatment of biomethane, for example gas scrubbing, pressure swing adsorption or membrane separation.

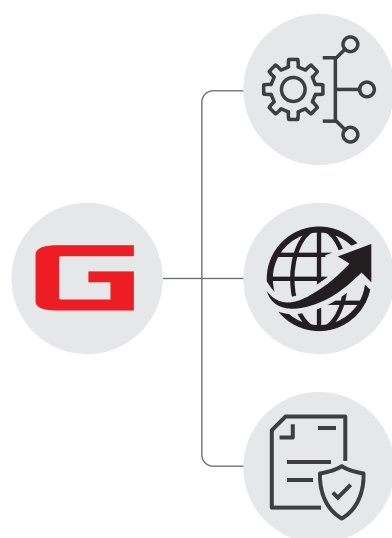

### **GEMÜ solutions from a single source**

As a system provider, we can react very flexibly to your needs on a case by case basis. We deliver both single components and complete systems – adjusted to your requirements.

### **Worldwide sales network**

As a globally active company, we achieve fast reaction times, customer oriented service all over the world and a committed project management team.

### **Quality is the top priority**

At GEMÜ, we only use carefully selected materials and our quality management system ensures continuous monitoring. This is also certified by external institutes.



As a medium, biogas and biomethane place stringent requirements on valves. Valves must cope with high switching cycles in biomethane treatment. Certain safety standards must be complied with when dealing with combustible gases in order to ensure plant reliability. No matter whether it's about the right valve selection or the appropriate approval. We are by your side in the selection of the appropriate valve.

#### Approvals for ignitable gases

Biogas plants are complex plants in which large quantities of ignitable gases are generated, stored and used.

To minimize the potential danger, we offer valves that comply with high safety standards like ATEX or SIL. Our range also includes valves with DVGW (German Technical and Scientific Association for Gas and Water) gas approval.

#### Professional control valve configuration

Inaccurate design of control valves can result in poor control results or premature wear. This is why GEMÜ places particular importance on the precise design of the control valves.

Our technical advisors support you personally in the configuration of control valves.

#### System solutions on a case by case basis

As a specialist in valve design, we also offer you system solutions on a case by case basis. These include, for example, small systems, partial sections and subassemblies, connection solutions on a case by case basis or test rigs and prototype construction.

#### Electrical solutions for local plants

For local plants, electrically operated valves can be an exciting alternative to pneumatics. GEMÜ offers a wide choice of motorized valves with integrated positioners and process controllers, as well as connection to common communication systems.

# Process landscape for biogas and biomethane treatment

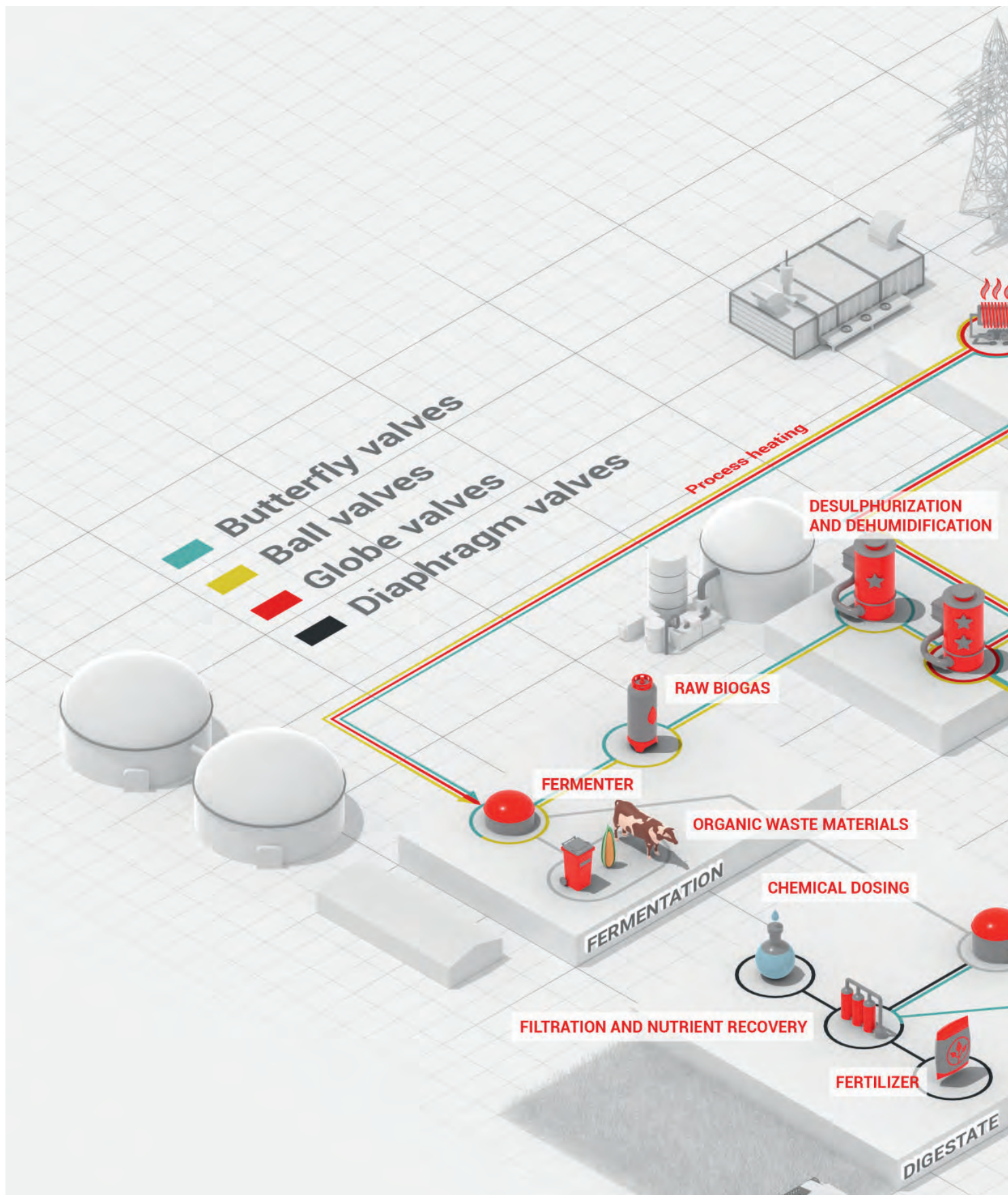





# Procedures in biogas or biomethane treatment

Biogas purification often sees multiple procedures combined in order to get the most out of the respective treatment steps. For example, this includes desulphurization through absorption (activated charcoal), drying through cooling through pressure swing adsorption (zeolite) and the procedure for removing CO<sub>2</sub> explained further down.

## Membrane separation process

Gas purification with polymer diaphragms adopts the different permeation properties of the gases. CO<sub>2</sub> and H<sub>2</sub>S permeate through the diaphragms much more easily, and can thus be discharged. Biomethane is created as a product at a high level of purity.

Since diaphragm systems usually have multiple layers, different pressure ratings need to be observed when selecting valve designs. In addition to control valves, this procedure also includes many manual valves in the plants.

## Gas scrubbers

Gas scrubbers can be operated with various media. In a pressurized water scrubber, the compressed biogas is cleaned with water. The CO<sub>2</sub> is physically separated in the water (absorption) and can be driven out into a second

column at lower pressures (desorption). The water can then be fed back to the absorption column.

Shut-off valves are used for pumps and tanks as well as for draining, while control valves are used for volume flow regulation of water. In addition to water, polyglycols (Genosorb or Selexol) can also be used in physical gas scrubbing. In contrast to physical adsorption, the chemical bond to the medium can be used in amine scrubbing. Once the CO<sub>2</sub> has been absorbed, the medium is also regenerated (usually by increasing the temperature) and is returned to the absorption column after it has cooled down.

In addition to the valves for pumps and tanks for isolation and draining, control valves are used here for volume flow regulation of the medium and at the heat exchangers for temperature control.

| Application  | Special operating parameters and requirements                          | What you need to pay attention to when selecting valves   |
|--|--|---|
| Gas scrubbers<br>Flow control<br>Temperature control | Desorption up to 100 °C, resistance to chemicals (amines or Genosorb®) | For water: Stainless steel bodies and EPDM seals<br>For amines/Genosorb®: Stainless steel bodies and PTFE seals                       |
| Membrane separation process<br>Pressure control      | Up to 10 bar, ambient temperature                                      | Cast bodies with NBR or PTFE seals, GEMÜ support for the precise configuration of control valves                                      |
| PSA systems  | Frequent cycle duties and sometimes a two-way flow                     | Often globe valves with actuators for high cycle duties. Suitable valve types for two-way flow include butterfly and diaphragm valves |



### Pressure swing adsorption via PSA systems

The functional principle, the basis of PSA systems, is adsorption followed by a pressure swing.

By transferring the gauge pressure between parallel adsorption tanks, continuous operation of the system is possible with high energy savings. During biomethane extraction, biogas flows into the purification tank (first tank). As a result, CO<sub>2</sub> is selectively adsorbed by the molecular sieves. Purified biomethane flows out. The second tank is regenerated (vented and flushed out), the CO<sub>2</sub> is released into the surrounding environment. For continuous operation, the two adsorption tanks are operated alternately between sorption (operation) and desorption (regeneration) cycles. Before a sorption cycle starts, a pressure swing is performed. From the saturated tank, the pressurized gas is transferred to the regenerated tank.

Typical requirements for valve designs are frequent cycle duties, sometimes at intervals of a minute. In the event of a pressure swing, some valves are also subject to two-way flow.

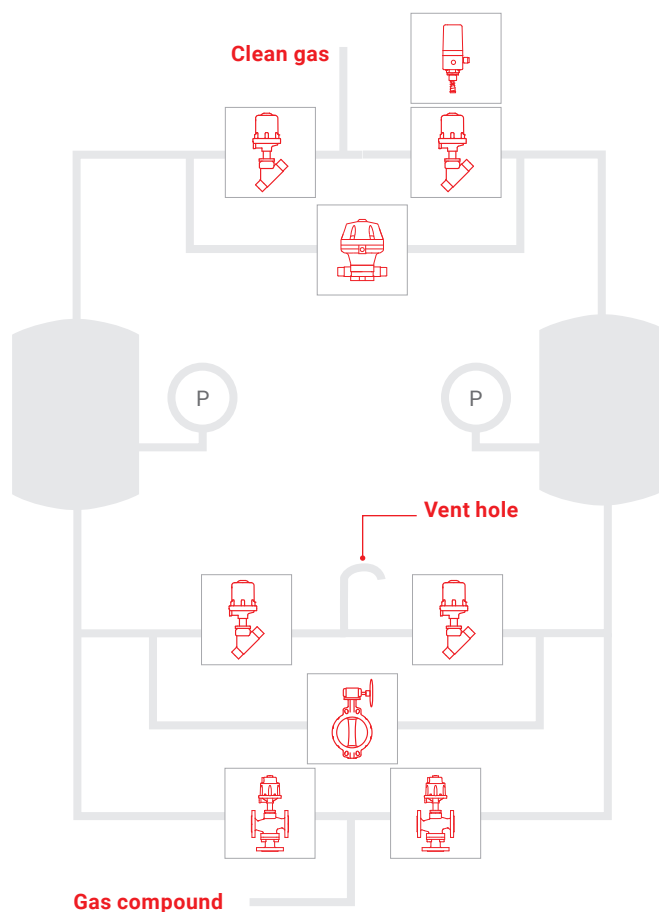

### Why GEMÜ?

For valve designs in gas scrubbers, membrane separation processes or PSA systems, GEMÜ offers technically advanced solutions adjusted to each process step.

No matter whether robust globe valves for high switching cycles or modular systems for a particularly compact design are required.

Due to the versatile valve types and accessories, we deliver the complete valves, measurement and control systems from a single source.

For pneumatic actuators, our positioners and process controllers are mounted ex works, tested and delivered as an entire system. This means that you also save on the time and effort required for logistics and installation of the system on site, as well as for documentation.



## Product examples by application

No other area subjects valves to such a versatile range of requirements as those found in industrial applications. Our decades of application experience feed directly into the new and further development of valves. That's why, even in this demanding environment, GEMÜ valves have proven so very successful to date.

GEMÜ products are in use around the globe in water treatment and waste water treatment, the chemical industry, power generation and environmental systems, the industrial plant and machinery sectors, the paper industry, steel works, mining and metal extraction, surface finishing and in many other areas.

The specific product range includes diaphragm valves, globe and control valves, butterfly valves, ball valves and

solenoid valves, each available in metal or plastic versions, as well as accessories for measurement and control systems. The wide field of applications makes GEMÜ valves reliable all-rounders. As customized system solutions, GEMÜ multi-port valve blocks in plastic and metal versions are being used successfully in industrial plant and process engineering.

# Configure GEMÜ valves easily online

## Go directly to the online product page using the web code

The web code consists of the abbreviation "GW-" and the respective product type. For example, the GEMÜ R690 diaphragm valve has the web code GW-R690. Enter the web code in the search frame on the GEMÜ website [www.gemu-group.com](http://www.gemu-group.com) and you will be taken straight to the associated product page. Alternatively, you can scan the QR code.

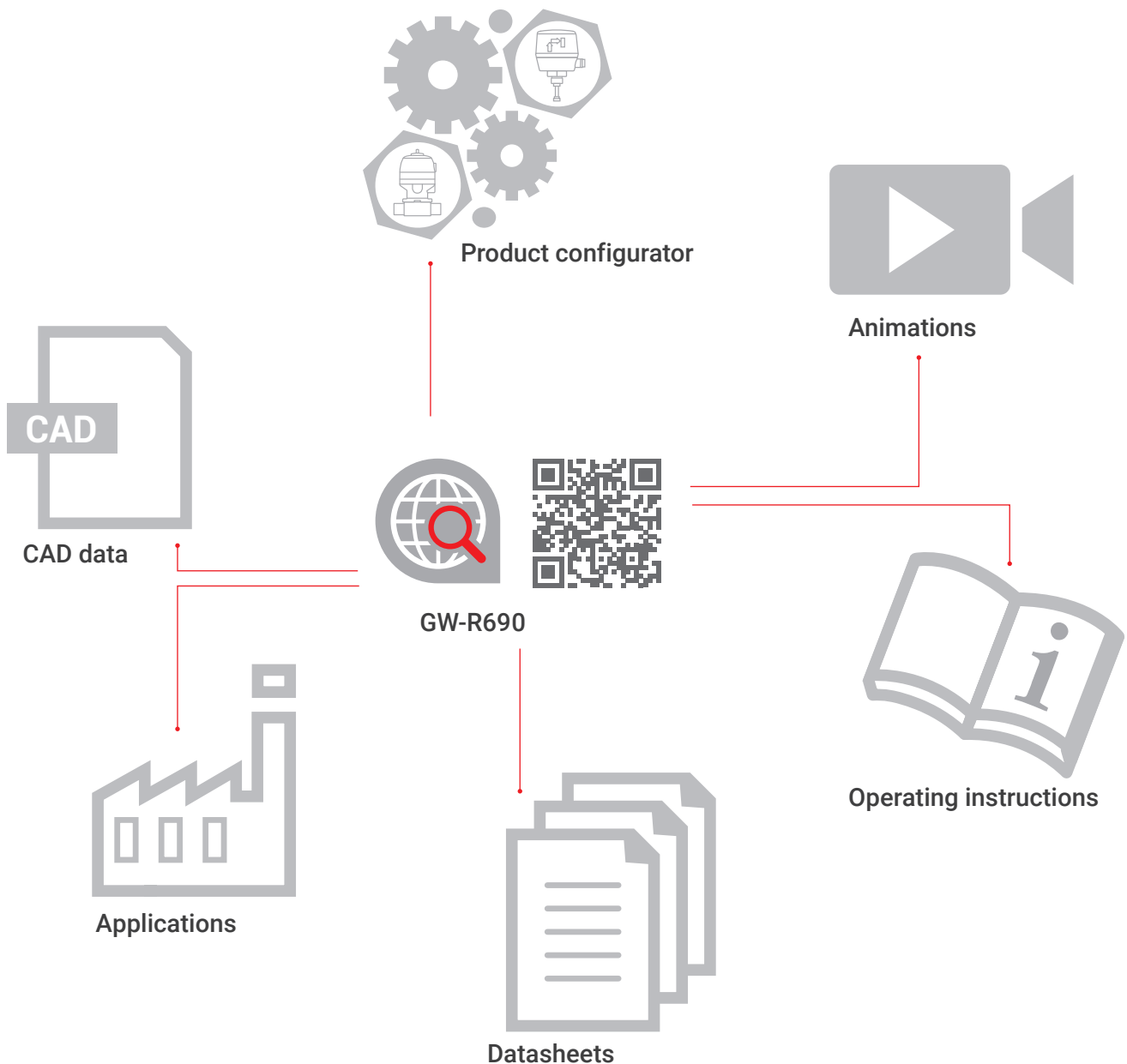

# Butterfly valves made of metal

## GEMÜ R470 Tugela and GEMÜ R480 Victoria

Thanks to the huge variety of materials, the GEMÜ butterfly valves are universally compatible. The construction enables many possible combinations of disc, liner and body. For all nominal sizes, butterfly valves are effective as short shut-off valves with high flow rate values. Various manual, pneumatic or motorized actuators are available for all GEMÜ butterfly valves.

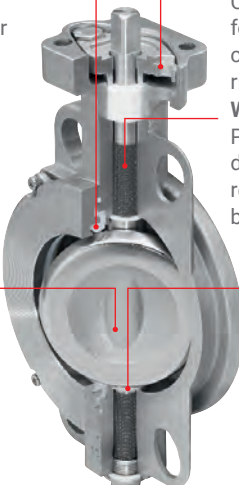

**Resistant**  
TFM sealing ring with excellent properties for chemical applications

**Reliable**  
Clamping system for sealing with concentricity control ring

**Wear-optimized**  
Protected spindle due to temperature resistant, copper alloy bush

**High-quality**  
Spherical surfaces for improved mechanical behaviour under pressure and temperature fluctuations

**Durable**  
Reduced friction of the disc due to double-eccentric structure



**Durable**  
Lower torques due to PTFE-coated bushes

**Smart**  
Liner material is easy to read when installed, compatible with CONEXO

**Flow-optimized**  
Sleek disc design for higher Kv values

**Made by GEMÜ**  
Narrow shape and positional tolerances and high-quality epoxy coatings thanks to in-house manufacturing capabilities

**Reliable**  
Optimized liner for technically flawless tightness

GEMÜ R470

Go online!     **TA Luft**  
(German Clean Air Act)

GEMÜ R480 Victoria

Go online!      **TA Luft**  
(German Clean Air Act)



Hand lever also available in yellow

### Areas of application



#### GEMÜ R470 Tugela, double-eccentric

- Pressure swing adsorption

#### GEMÜ R480 Victoria

- Biogas plant
- Pressurized water scrubbers
- Membrane processes
- Heating networks

# Ball valves made of metal

## GEMÜ B20, GEMÜ BB02 and GEMÜ BB06

Ball valves are versatile and can also be used in extreme circumstances. With the ball that has been drilled through as a shut-off body, this valve type is particularly well-suited to safely shutting off liquid and gaseous media at a very high operating pressure. As the medium travels between the ball and the body when opening and closing, ball valves are suitable for mechanically pure, inert or corrosive liquids, gases or steam.

**Lockable**  
Manually operated and lockable

**Compact**  
Length standardized to DIN EN 3202 M3

**Lightweight**  
Low weight

**Flexible**  
Different standard connections  
DIN, NPT thread

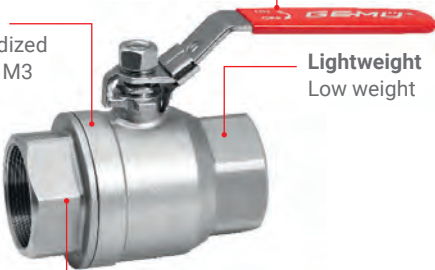

**Modular**  
Three-piece body design enables simple mounting

**Automation-capable**  
ISO 5211 top flange for simple actuator mounting

**Flexible**  
Freely selectable, different actuators can be mounted

**Variable**  
Different connection options, butt weld spigots in extended orbital welding design

**Qualitative**  
Design to DIN 12516-2, ASME 16.34

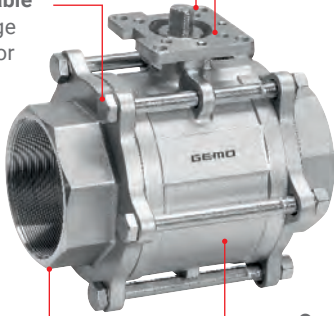

GEMÜ B20

Go online!      

GEMÜ BB02

Go online!     

 **Areas of application**

- Biogas plant
- Membrane processes
- Gas scrubbers
- Heating networks



Also available as a compact flanged ball valve

GEMÜ BB06

Go online!     

# Globe valves made of metal

## GEMÜ 534 and GEMÜ 554

Globe valves are suitable for clean, liquid media as well as gases and steam. Due to the linear movement and favourable mechanical conditions, they often take on automated tasks like frequent cycle duties in PSA systems, and control tasks in cooling water and biogas regulation.

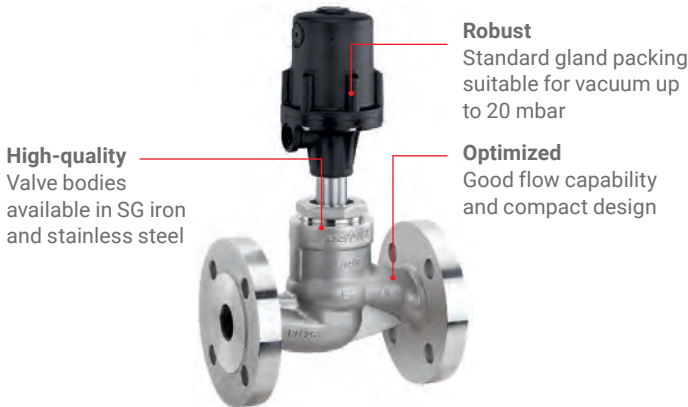

Also available as angle seat globe valve

GEMÜ 534

Go online!     **TA Luft**  
(German Clean Air Act)

GEMÜ 554

Go online!     **TA Luft**  
(German Clean Air Act)

Other versions:

GEMÜ 550 acc. to EN 161 based on special function G available for ordering. EN 161 is an extra approval for GAS.



### Areas of application

- PSA system
- Membrane processes
- Gas scrubbers
- Heating networks

# Modular distribution valve

## GEMÜ 553

The modular GEMÜ 553 distribution valve comprises various globe valve modules. These can be equipped with manual, pneumatic or motorized actuators. The downstream media is isolated using a PTFE seal. The valve spindle is sealed by a self-adjusting gland packing. This provides a low-maintenance and reliable valve spindle sealing even after an extended operating time. The wiper ring that is installed upstream of the gland packing also protects this against contamination and damage. The single modules are simple to join via screws.

### Advantages

- Simple to extend
- Versatile range of accessories
- Compact design
- Simple integration of sensor system
- Versatile adaptation options
- Outlets can be turned in steps of 90°
- Filters or separation of media can be integrated

GEMÜ 553



Configuration example

# Modular distribution valve

## GEMÜ 553

The GEMÜ P500M stainless steel valve block comprises two or more globe valves. These can be equipped with manual, pneumatic and motorized actuators. The downstream media is isolated using a valve plug.

### Advantages

- Space savings due to compact design
- Individual, customized and flexible design
- Fewer connection points and weld seams
- Most varied functions combined in the smallest of spaces
- Very suitable for control applications
- Actuators, gland packing and automation components can be used from the tried and tested GEMÜ modular system

GEMÜ P500M



# Globe valves as control valves

Thanks to the long stroke distance, combined simultaneously with the low cross-section increase at the valve seat, GEMÜ globe valves are optimally suited to control tasks. Moreover, they are distinguished by jolt-free actuation and a long service life in terms of switching frequency.

## This is how a globe valve becomes a control valve

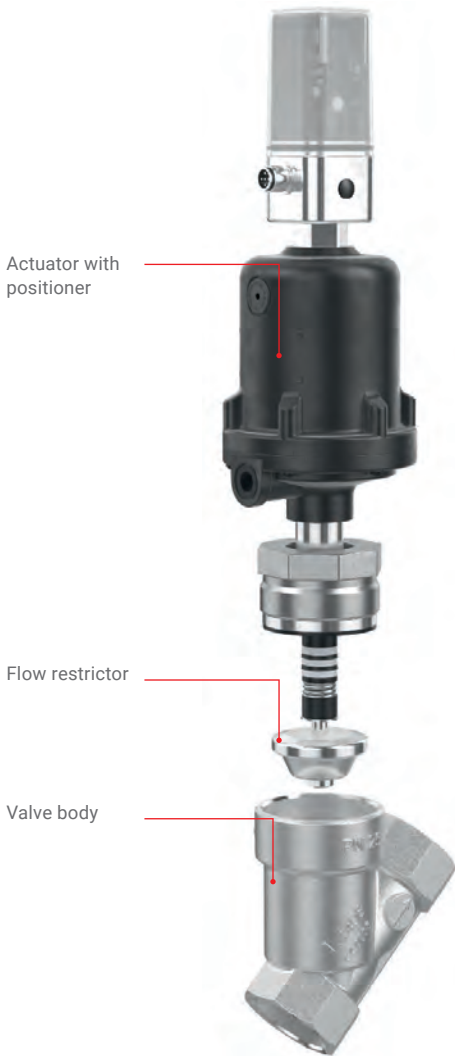

## Flow restrictors with different geometries

With opening of the valve to an increasing degree, the flow restrictor changes the ring-shaped gap at the valve seat within a defined control characteristic. Depending on the type of globe valve and the nominal size, flow restrictors may feature the most varied geometries.

Regulating needles are used for very small nominal sizes and high pressures because they can control with high precision. For larger diameters, modified regulating cones or regulating cages are preferred for weight reasons.

The most frequently used control characteristics are linear and equal-percentage 1:25 and 1:50. Linear means that the flow increases linearly with the opening stroke of the valve. The flow is 50% at the 50% open valve position. This provides good valve control over the total stroke range. The equal-percentage control characteristics have the character of an exponential function. In the lower range, with an opening stroke of approx. 20% to 60%, these valves can be very finely controlled depending on the valve stroke.



Regulating needle



Regulating cone



Regulating cage

The wrong design of control valves can result in poor control results or premature wear. This is why GEMÜ places particular importance on the precise design of the control valves.

Our technical advisors and specification sheet can help you to design control valves.

# Overview of control systems

## Pneumatic



GEMÜ PCS 514



GEMÜ PCS 550



GEMÜ PCS 554



GEMÜ PCS 530



GEMÜ PCS 532



GEMÜ PCS 534



GEMÜ PCS 536

## Electrical



533 eSyStep



543 eSyStep



539 eSyDrive



549 eSyDrive



343 eSyDrive

For pneumatic actuators, our positioners and process controllers are mounted ex works and tested and delivered as an entire system. Not only can you obtain all components from a single source, you simultaneously reduce the effort required for logistics and installation of the system on site, as well as for documentation.



For motorized actuators, the controller is mostly fully integrated. These actuators are an optimal alternative to control valves in sterile environments or when considering service life. If required, the respective positioner can also be commissioned at the place of use by GEMÜ service engineers.

# Diaphragm valves in plastic and metal

## GEMÜ 695 and GEMÜ R690

The diaphragm valve is practically the all-rounder amongst valves. One of its major advantages is that only two components come into contact with the working medium – the diaphragm and the valve body. The media wetted inner geometry is designed to keep flow turbulences as low as possible, and there is almost no opportunity for product deposits or sediment.

**Position indicator**  
Integrated as standard

**Optimized cleanability**  
Thanks to rounded actuator cover

**Bolting from below**  
For protection against contamination

**RFID retainer**  
For integration into CONEXO system

**Operating pressure of 10 bar**  
For EPDM and PTFE diaphragms (diaphragm sizes 25 to 50)

**Solid control air bush**  
Made of brass



Also available as plastic version

GEMÜ 695

Go online!    
**GW-695**

**TA Luft**  
(German Clean Air Act)

GEMÜ R690

Go online!    
**GW-R690**

### Areas of application



#### GEMÜ 695

- PSA system
- Digestate treatment (pressure and temperature)
- Gas scrubbers

#### GEMÜ R690

- Digestate treatment (chemical dosing)

# Further process accessories



GEMÜ 1434 µPos positioner



GEMÜ 1435 ePos positioner



GEMÜ 1436 cPos positioner



GEMÜ 1441 positioner



GEMÜ LSF inductive dual sensor



GEMÜ LSC limit switch box

For linear valves

For quarter turn valves



GEMÜ 514 angle seat globe valve



GEMÜ R690 diaphragm valve



GEMÜ B46 ball valve



GEMÜ R481 butterfly valve



GEMÜ 805 flowmeter



GEMÜ 3140 and 3240 pressure and temperature sensors



GEMÜ 8253 solenoid valve



GEMÜ ZRSK check valve

# GEMÜ portfolio at a glance

The following table aims to give you an overview of which valve function is most appropriate for which processes and media. In addition to these categories, we also offer valves for special applications.

| Criterion                       | Diaphragm valves |              | Globe valves | Butterfly valves     |              |
|---------------------------------|------------------|--------------|--------------|----------------------|--------------|
|                                 | Metal            | Plastic      | Metal        | Metal                | Plastic      |
| <b>MEDIUM</b>                   |                  |              |              |                      |              |
| Gaseous                         | ○                | ○            | ●            | –                    | –            |
| Steam                           | ○                | –            | ●            | ●                    | –            |
| Liquid                          | ●                | ●            | ●            | ●                    | ●            |
| Viscous                         | ●                | ●            | ○            | ●                    | ●            |
| Particulate, abrasive           | ●                | ○            | –            | ○                    | ●            |
| Granular                        | ○                | ○            | –            | ○                    | ●            |
| Corrosive (depends on material) | ●                | ●            | –            | –                    | ●            |
| <b>PROCESS</b>                  |                  |              |              |                      |              |
| Multi-port design available     | ●                | ●            | ●            | –                    | –            |
| Piggable                        | –                | –            | –            | –                    | –            |
| Controllable                    | ○                | ○            | ●            | For larger diameters |              |
| Media temperature               | Up to 100 °C     | Up to 80 °C  | Up to 185 °C | Up to 230 °C         | Up to 90 °C  |
| Operating pressure              | Up to 10 bar     | Up to 10 bar | Up to 40 bar | Up to 40 bar         | Up to 10 bar |
| Frequent cycle duties           | ○                | ○            | ●            | –                    | –            |

- \* Higher levels on request
- Very suitable
- Conditionally suitable
- Not suitable

## Further process accessories



Flowmeters



Pressure and temperature sensors

| Criterion                       | Ball valves   |              | Diaphragm globe valves | Process solenoid valves |             |
|---------------------------------|---------------|--------------|------------------------|-------------------------|-------------|
|                                 | Metal         | Plastic      | Plastic                | Metal                   | Plastic     |
| <b>MEDIUM</b>                   |               |              |                        |                         |             |
| Gaseous                         | ●             | ●            | ●                      | -                       | -           |
| Steam                           | ●             | ●            | ●                      | -                       | -           |
| Liquid                          | ●             | ●            | ●                      | ●                       | ●           |
| Viscous                         | ●             | ●            | ●                      | ●                       | ●           |
| Particulate, abrasive           | -             | -            | -                      | -                       | -           |
| Granular                        | -             | -            | -                      | -                       | -           |
| Corrosive (depends on material) | -             | ●            | ●                      | -                       | ●           |
| <b>PROCESS</b>                  |               |              |                        |                         |             |
| Multi-port design available     | ●             | ●            | ●                      | ●                       | -           |
| Piggable                        | ●             | ●            | -                      | -                       | -           |
| Controllable                    | ●             | -            | ●                      | -                       | -           |
| Media temperature               | Up to 220 °C  | Up to 100 °C | Up to 150 °C           | Up to 60 °C             | Up to 60 °C |
| Operating pressure              | Up to 137 bar | Up to 16 bar | Up to 6 bar            | Up to 20 bar            | Up to 6 bar |
| Frequent cycle duties           | -             | -            | ●                      | ●                       | ●           |

- \* Higher levels on request  
● Very suitable  
○ Conditionally suitable  
- Not suitable



Control systems

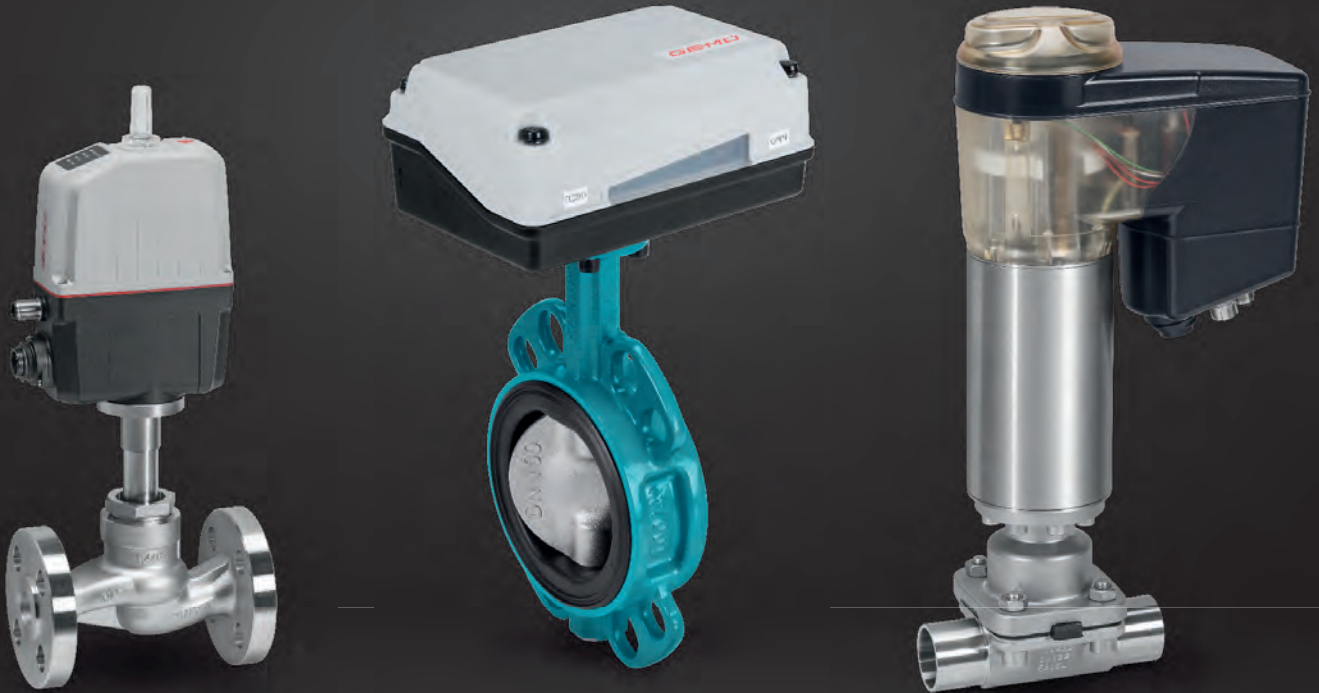

## Keeping up with the current of time – electrical valves for plant engineering

Electrification is changing the processing industry and, in doing so, is offering versatile options for optimizing plant engineering. For compact plants or local plants without a separate compressed air supply, electrical valves can be an energy-efficient alternative to pneumatics.

For more than 55 years, we have been developing electromagnetic and motorized actuators, thereby continuously building up our expertise.



**GEMÜ eSyDrive**  
Premium actuator for complex Open/Closed and dynamic control applications



**GEMÜ eSyStep**  
Universal actuator for Open/Closed and simple control applications



**GEMÜ eSyLite**  
Basic actuator for Open/Closed applications



More on our electrical actuators for linear and quarter turn valves can be found at [www.gemu-group.com/electric-valves](http://www.gemu-group.com/electric-valves)



## Process reliability due to tested quality

If you value high quality, in-house quality assurance is a must. That's why the GEMÜ test laboratory is equipped with state-of-the-art measuring equipment to allow comprehensive testing of our products. This also enables us to test the performance of highly customized designs in order to determine the parameters for the most cost effective operation.

At GEMÜ, we only use carefully selected materials and our quality management system ensures continuous monitoring. External institutes also testify to this quality.



TÜVRheinland®  
**CERT**  
ISO 14001



TÜVRheinland®  
**CERT**  
ISO 9001

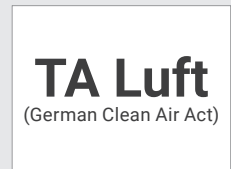



## Customized solutions

As a partner to its customers, GEMÜ would like you to be able to fully utilize your plant potential. That's why we also offer high-grade modifications right up to customized valve concepts on a case by case basis, in addition to our standard range.

Whether it concerns a modification or a new development, our modular system with proven standard modules allows plenty of flexibility for design possibilities on a case by case basis.

### Extensive standard range

With a wide choice of operating principles, materials and connection standards



### Product modification

Application-optimized such as special coatings or extended material selection



### New development

In close collaboration between customers and experienced GEMÜ engineers



### Challenge us!

There is a lot more to find behind the GEMÜ standard product range.

**Contact us for advice on a case by case basis.**

# GEMÜ app

## Numerous functions in one mobile application

### Take a step with us into a mobile era!

Discover the new GEMÜ app – with numerous functions that simplify your life. The complete GEMÜ product range will also be available with immediate effect – from the convenience of your pocket. With our app for smartphones and tablets, you can call up product information anywhere and benefit from our digital services.

### Advantages

- Product documentation on all GEMÜ products can be downloaded while you're on the go
- Call up item-specific information without spending a long time searching
- Clear identification of GEMÜ products with QR code or RFID tag
- Convenient operation and configuration for GEMÜ products with Bluetooth interface
- Quick and easy way to get in touch

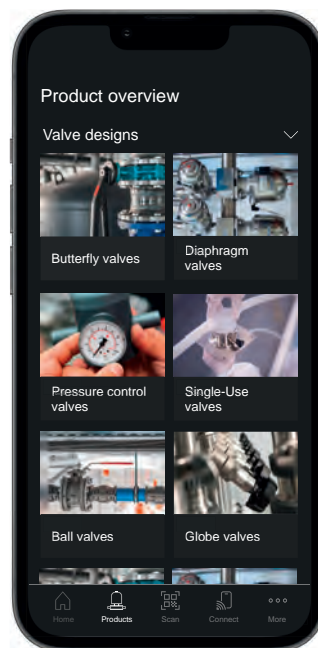

# CONEXO

## Digital information management and maintenance support

In addition to clear identification of components, CONEXO also offers support with the qualification of plants and paperless maintenance. Identification is done via an RFID chip using the CONEXO pen or via a QR code with CONEXO Webview and the GEMÜ app directly on the component within the plant.

### Identification

- Electronic identification of components using CONEXO tags (QR code or RFID chip)
- Scanning the CONEXO tag
- Displaying the product information and documentation

### Documentation

- Construction of the plant structure on the CONEXO portal
- Integration of the component data
- Creation of step-by-step instructions for each maintenance type
- Definition of the maintenance tasks with location, cycle, implementation period and operator

### Maintenance support

- Implementation of maintenance work via step-by-step instructions
- Automatic documentation of implementation
- Electronic signature through user login
- Distribution of the maintenance report via PDF
- Calling up the maintenance report

### Digital name plate

Since mid-2021, in addition to the normal product label, GEMÜ products have gradually also included an additional label with a QR code and serial number. You can use this to positively identify our products all over the world and, in addition to the classic product label, call up lots of additional product-related information in digital format.





**GEMÜ Gebr. Müller Apparatebau GmbH & Co. KG**  
Fritz-Müller-Straße 6–8 · 74653 Ingelfingen · Germany  
Phone +49 (0) 7940 123 0 · [info@gemue.de](mailto:info@gemue.de)

[www.gemu-group.com](http://www.gemu-group.com)